

IDENTIFYING CCI COMPRESSORS

The metal nameplate located at the top front of the compressor serves as a means of identification. The location permits viewing the nameplate with the clutch installed.

Data inscribed on the nameplate includes the serial number, combination model/part number, date of manufacture and type of refrigerant.

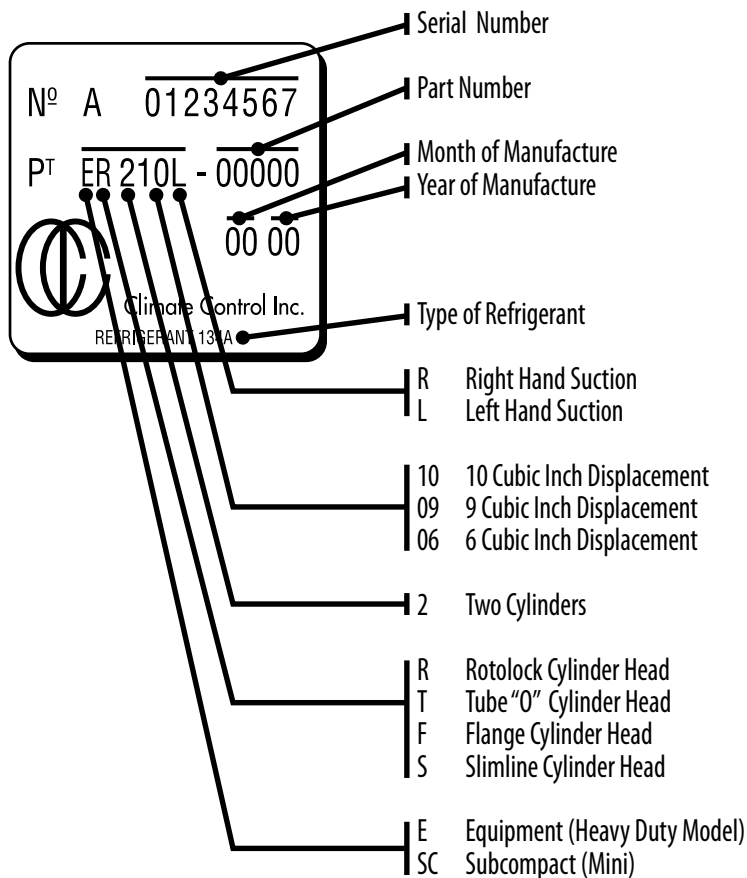

CCI HEAD TYPES

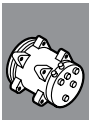
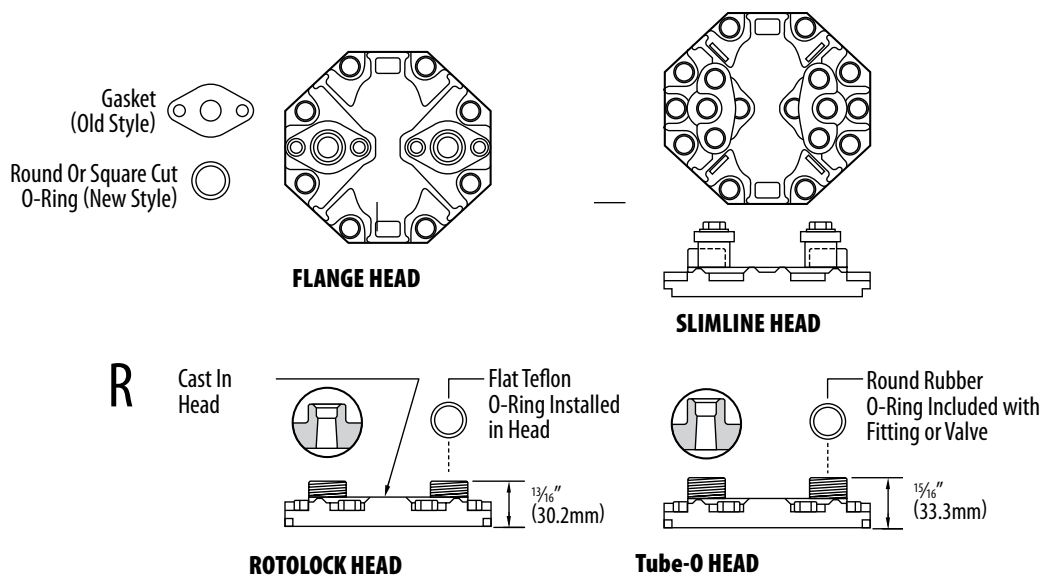

# 75R SERIES

## CCI/YORK/TECUMSEH COMPRESSORS

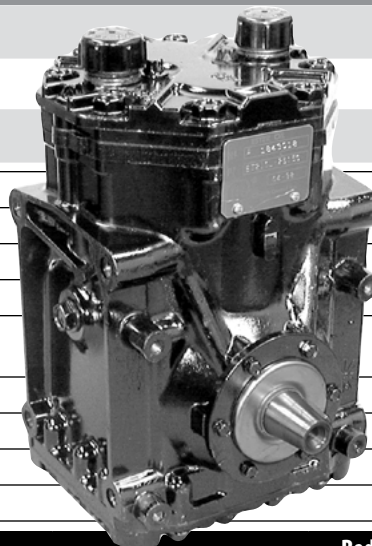

Bore	1.875 (47.6mm)
Stroke	1.876 47.4mm)
Displacement per Revolution	10.3 cu. in. (170cc)
Number of Cylinders	2
Maximum Allowable Continuous R.P.M. (Normal Operating Conditions)	6,000
Refrigerant	R-12/134A
Oil (PAG)	10 fl. oz. (200cc)
Weight	14.6 lbs. (6.6 kg.)
Rotation	Clockwise or Counter Clockwise

OE Model No.	Fitting Size	Red Dot Part No.	Factory Part No.	Note	Clutch Type	Gauge Line	Number of Wires Connector Type	Red Dot Clutch Part No.	RD Factory Clutch Part No.
--------------	--------------	------------------	------------------	------	-------------	------------	--------------------------------	-------------------------	----------------------------

### ROTOLOCK, 12 VOLT

#### LH Suction, R-12/R134a

ER210L-21237 ER210L-25062 ER210L-25149, 99242-5	½" x 5/8"	<b>75R7280</b>	RD-5-8637-0P	1	Supplied without clutch	N/A	N/A	See clutch section	
ER210L-21237 ER210L-25427	½" x 5/8"	<b>75R7285</b>	RD-5-8060-1P	3	Supplied without clutch	N/A	N/A	See clutch section	

### TUBE-O-RING, 12 VOLT

#### LH Suction, R-12/R134a

ET210L-21160 ET210L-25061 ET210L-25150,-C 99244-5	1" - 14	<b>75R7290</b>	RD-5-8638-0P	1	Supplied without clutch	N/A	N/A	See clutch section	
ET210L-25073C	1" - 14	<b>75R7312</b>	RD-5-11217-0P	5	6", 2 Groove, ½"	1 5/8"	1, Weatherpak	<b>75R1202</b>	RD-5-4972-1P
ET210L-25237C	1" - 14	<b>75R7322</b>	RD-5-11218-0P	5	6", 2 Groove, ½"	1 5/8"	2, Metripak	<b>75R1302</b>	RD-5-9456-0P
ET210L-25240C	1" - 14	NA	RD-5-14049-0P	5	5 ¾", Poly 6, .014"	2"	2, Metripak	<b>75R0502</b>	RD-5-10363-0P
ET210L-25246C	1" - 14	<b>75R7332</b>	RD-5-11219-0P	5	6 ½", Poly 8, .014"	1 15/16"	2, Metripak	<b>75R0682</b>	RD-5-10365-0P
ET210L-21160 ET210L-25428 ET210L-25428C	½" x 5/8"	<b>75R7295</b>	RD-5-8061-1P	3	Supplied without clutch	N/A	N/A	<b>75R1202</b>	RD-5-4972-1P
ET210L-25405C	1" - 14	<b>75R7342</b>	RD-5-14641-0P	1	6", 1 Groove, ½"	2.71	1	N/A	N/A
ET210L-25406C	1" - 14	<b>75R7352</b>	RD-5-14642-0P	1	6 ¼", 1 Groove, ½"	2.71	1	N/A	N/A

### SLIMLINE SERIES HEAD

#### INSERT TUBE, R-12/R134a

ES210L-25334	1" - 14	<b>75R7300</b>	RD-5-10029-0P	Note 5	Supplied without clutch	N/A	N/A	See clutch section	
--------------	---------	----------------	---------------	--------	-------------------------	-----	-----	--------------------	--

#### MINI STAT-O-SEAL

##### LH Suction, R-12/R134a

ES210L-25334C	1" - 14	<b>75R7300</b>	RD-5-10029-0P	Note 5	Supplied without clutch	N/A	N/A	See clutch section	
---------------	---------	----------------	---------------	--------	-------------------------	-----	-----	--------------------	--

**Notes:** Generic Compressors are OEM factory built but may contain noncritical reconditioned components

- |   |  |
|---|--|
| <b>1</b> Universal, Standard Duty with Super Screws, Felt Ring, PRV and Ester Oil | <b>5</b> OE Replacement, Standard Duty |
| <b>2</b> Standard Generic, with Super Screws, Felt Ring, PRV and Ester Oil        | <b>6</b> Tube O with Ford Connector    |
| <b>3</b> Super HD Generic, with Super Screws, Felt Ring, PRV and Ester Oil        |  |
| <b>4</b> Rotolock with 2 Groove clutch  |  |

**75R8102** RD-5-5000-0P

GMC A6R, Generic  
 Superheat switch port  
 5" Single Groove Clutch – 12 volt  
 Pulley with ½" – ¾" variable groove  
 R-12/R134a – no oil  
 Standard thread mounting holes  
 Clockwise rotation

**75R8184** RD-5-7566-0P

GMC A6R, New  
 Without Superheat switch port  
 7" Single Groove Clutch 24 volt  
 Pulley with ½" – ¾" variable groove  
 R-12  
 Shipped with 10 oz. mineral oil  
 Metric thread mounting holes  
 Clockwise rotation



**NOTE:** Generic Compressors are OEM factory built but may contain noncritical reconditioned components

Complete your compressor installation. Replace the receiver drier as per manufacturer's recommendation. Check all O-Rings and hoses. And use Red Dot's easy O-Ring Assortment Kit

**70R5020**

## RD-5-9987-0P



# 75R SERIES

## NIPPONDENSO-EQUIVALENT / SAMLIN COMPRESSORS



### MANIFOLDS

Part Number	Factory No.	Model Description
<b>75R8920</b>	RD-5-11151-0P	Nippondenso Manifold - Top discharge with oil bypass, #8 and #10 Male Insert O-Ring fittings
<b>75R8921</b>	RD-5-11152-0P	Nippondenso Manifold - Rear discharge, #8 and #10 Male Insert O-Ring fittings
<b>75R8915</b>	RD-5-11047-0P	Nippondenso Molded Manifold Seal



OEM P/N	Part Number	Factory Number
<b>Caterpillar</b>		
178-5545	<b>75R9044</b>	RD-5-14070-0P
245-7779	<b>75R9044</b>	RD-5-14070-0P
259-7243	<b>75R9044</b>	RD-5-14070-0P
305-0324	<b>75R9044</b>	RD-5-14070-0P
305-0325	<b>75R9044</b>	RD-5-14070-0P
<b>Freightliner</b>		
22-65770-000	<b>75R9072</b>	RD-5-14644-0P
22-65771-000	<b>75R9082</b>	RD-5-14645-0P
22-65772-000	<b>75R9092</b>	RD-5-14646-0P
<b>Hitachi Construction</b>		
4361053	<b>75R9004</b>	RD-5-14066-0P
<b>John Deere</b>		
4333459	<b>75R9004</b>	RD-5-14066-0P
4431081	<b>75R9034</b>	RD-5-14069-0P
4436025	<b>75R9034</b>	RD-5-14069-0P
AT166518	<b>75R9004</b>	RD-5-14066-0P

OEM P/N	Part Number	Factory Number
<b>John Deere</b>		
AH169875	<b>75R9052</b>	RD-5-14079-0P
AT163728	<b>75R9024</b>	RD-5-14068-0P
AT168543	<b>75R9014</b>	RD-5-14067-0P
AT172975	<b>75R9014</b>	RD-5-14067-0P
AT226273	<b>75R9014</b>	RD-5-14067-0P
RE46609	<b>75R9052</b>	RD-5-14079-0P
RE46657	<b>75R9062</b>	RD-5-14080-0P
TY24304	<b>75R9052</b>	RD-5-14079-0P
TY6764	<b>75R9052</b>	RD-5-14079-0P
TY6783	<b>75R9024</b>	RD-5-14068-0P
<b>Komatsu</b>		
11Y-979-5450	<b>75R9004</b>	RD-5-14066-0P
134-X11-1250	<b>75R9004</b>	RD-5-14066-0P
14X-Z11-8580	<b>75R9004</b>	RD-5-14066-0P
17A-911-4810	<b>75R9034</b>	RD-5-14069-0P
195-911-7510	<b>75R9004</b>	RD-5-14066-0P

OEM P/N	Part Number	Factory Number
<b>Komatsu</b>		
195-911-8990	<b>75R9004</b>	RD-5-14066-0P
198-911-9580	<b>75R9004</b>	RD-5-14066-0P
20Y-810-1260	<b>75R9034</b>	RD-5-14069-0P
20Y-979-3110	<b>75R9004</b>	RD-5-14066-0P
20Y-979-3111	<b>75R9004</b>	RD-5-14066-0P
20Y-979-6121	<b>75R9034</b>	RD-5-14069-0P
20Y-979-8130	<b>75R9004</b>	RD-5-14066-0P
21N-979-1360	<b>75R9004</b>	RD-5-14066-0P
418-S62-3160	<b>75R9034</b>	RD-5-14069-0P
418-S62-3161	<b>75R9034</b>	RD-5-14069-0P
421-07-11210	<b>75R9034</b>	RD-5-14069-0P
421-07-31220	<b>75R9034</b>	RD-5-14069-0P
421-07-31221	<b>75R9034</b>	RD-5-14069-0P
425-07-21180	<b>75R9004</b>	RD-5-14066-0P
425-07-21190	<b>75R9004</b>	RD-5-14066-0P
42C-07-11210	<b>75R9004</b>	RD-5-14066-0P

**NIPPONDENSO-EQUIVALENT / SAMLIN COMPRESSORS**

Compressors are shown with shipping plate or rubber pad

**75R9004 RD-5-14066-0P**

Model: 10PA15C  
Clutch: 152mm 1A Groove Clutch (fits 0.5" wide belt)  
Voltage: 24



**75R9044 RD-5-14070-0P**

Model: 10S17C  
Clutch: 140mm PV8 Clutch  
Voltage: 24



**75R9082 RD-5-14645-0P**

Model: 10S15C  
Clutch: 164mm PV8 Clutch  
Voltage: 12



**75R9014 RD-5-14067-0P**

Model: 10PA17C  
Clutch: 145mm PV8 Clutch  
Voltage: 24

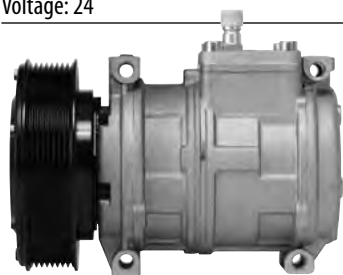

**75R9052 RD-5-14079-0P**

Model: 10PA17C  
Clutch: 145mm PV8 Clutch  
Voltage: 12

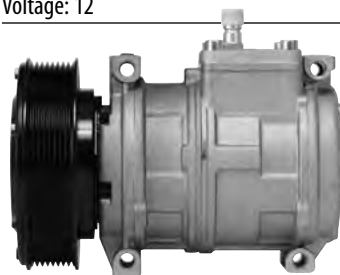

**75R9092 RD-5-14646-0P**

Model: 10S15C  
Clutch: 140mm PV6 Clutch  
Voltage: 12



**75R9024 RD-5-14068-0P**

Model: 10PA17C  
Clutch: 146mm 1A Groove Clutch (fits 0.5" wide belt)  
Voltage: 24

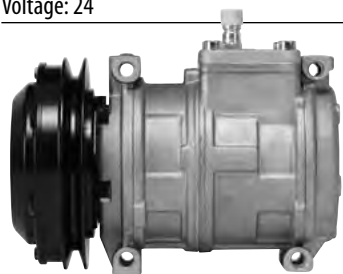

**75R9062 RD-5-14080-0P**

Model: 10PA15C  
Clutch: 152mm 1A Groove Clutch (fits 0.5" wide belt)  
Voltage: 12

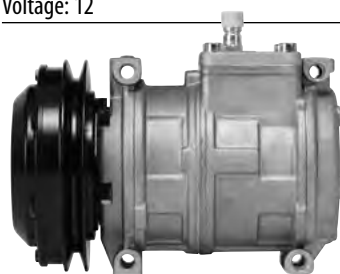

**75R9034 RD-5-14069-0P**

Model: 10S15C  
Clutch: 152mm 1B Groove Clutch (fits 0.66" wide belt)  
Voltage: 24



**75R9072 RD-5-14644-0P**

Model: 10S15C  
Clutch: 140mm PV8 Clutch  
Voltage: 12

